



360°

— —
— —
— —





1.1

“ ” “ ” “ ” “ ” “ ” “ ”

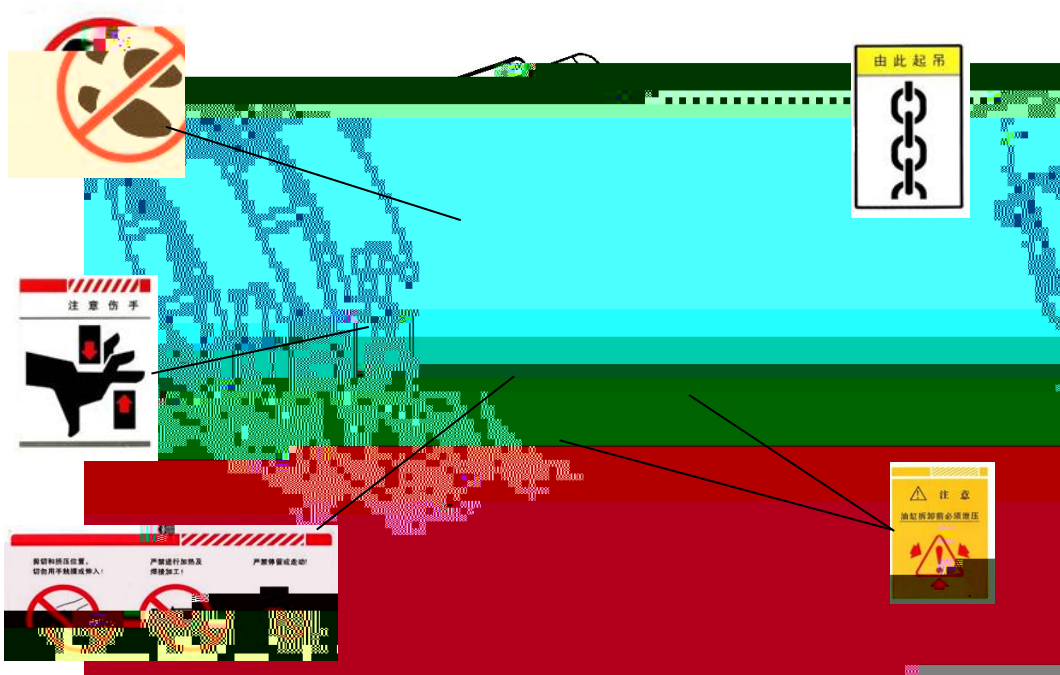



1.2



1. 3. 2

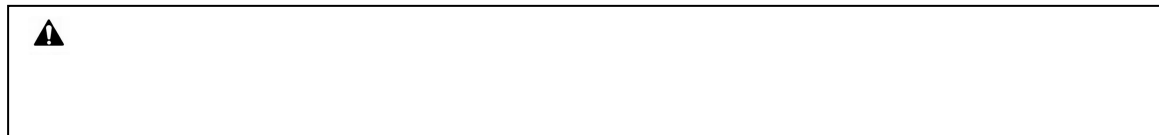

1. 3. 3

80

80

1. 3. 4



— —



— —

— —

— —



2.1

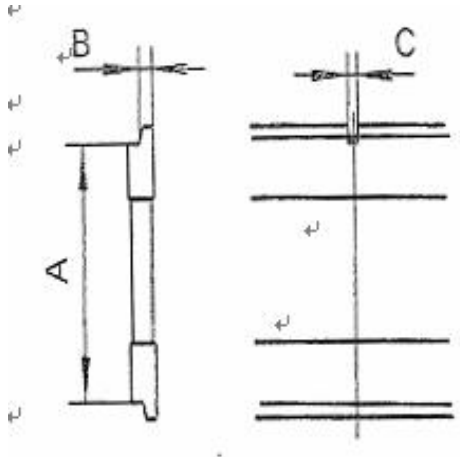

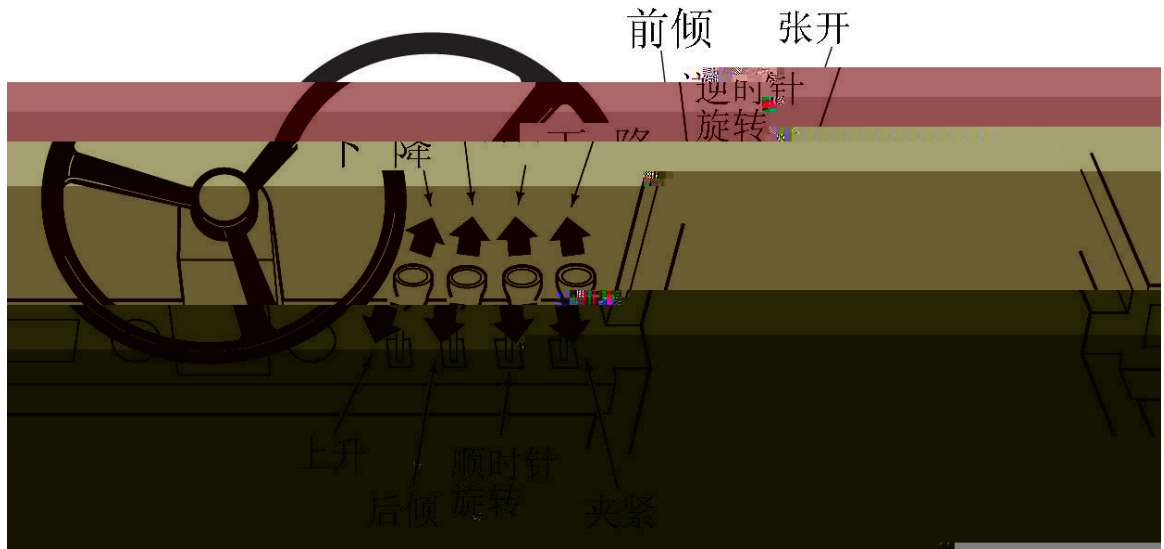

2.4

	Bar		L/min		
ZJ13H ZJ13/12/11/10R	140	160	19	26	38
ZJ22/25/27/33H	140	160	19	38	57
ZJ35/45R/ZJ38/46H	140	160	38	57	76





3

3.1

- 1、拆除包装，将属具吊起，垂直放置与托盘上。
- 2、拆除下钩。

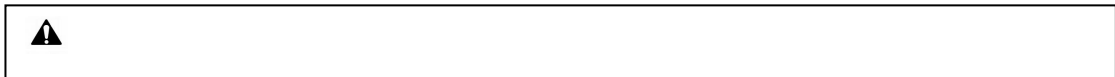
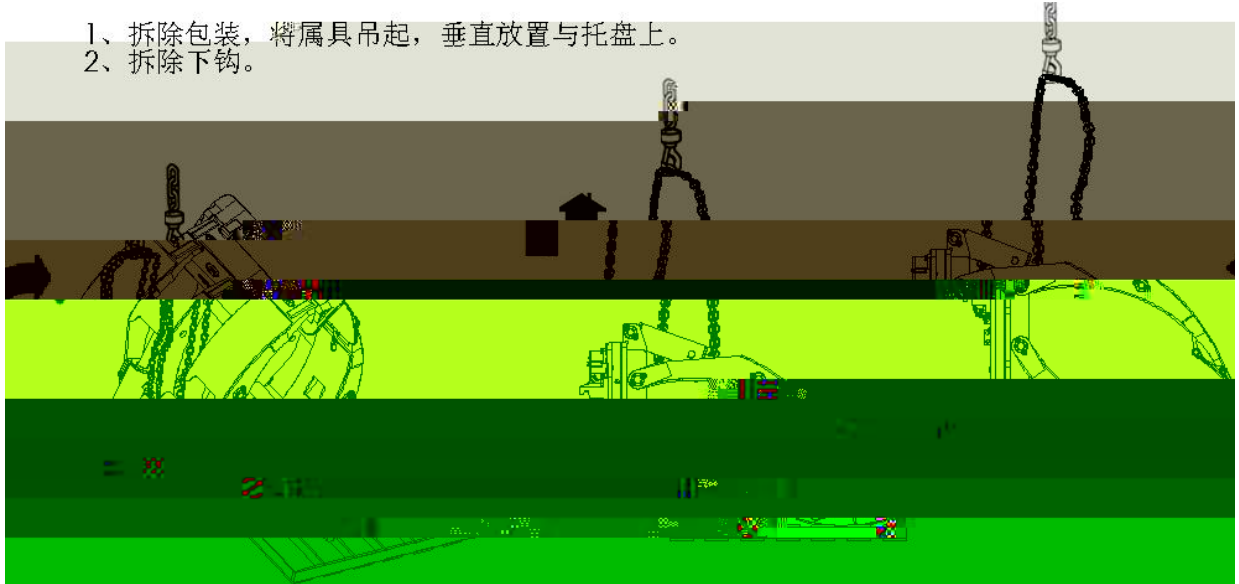

3.2

30

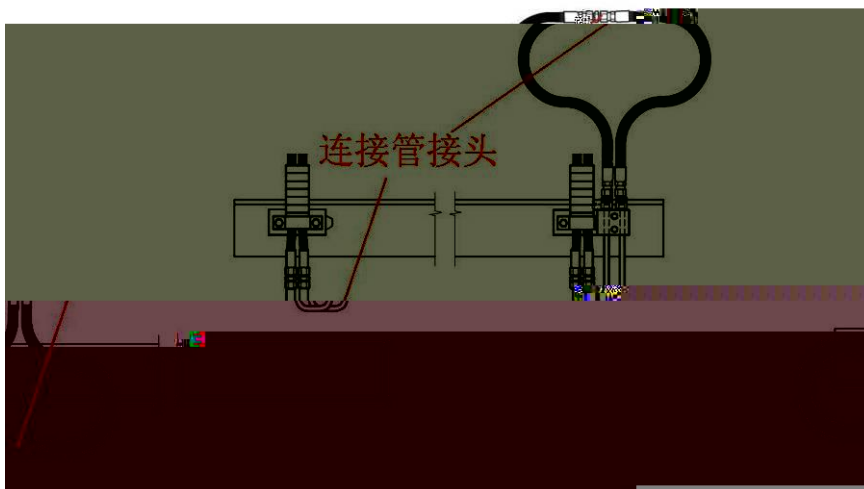

3.3

3.4



5cm

3.5

142 155N m

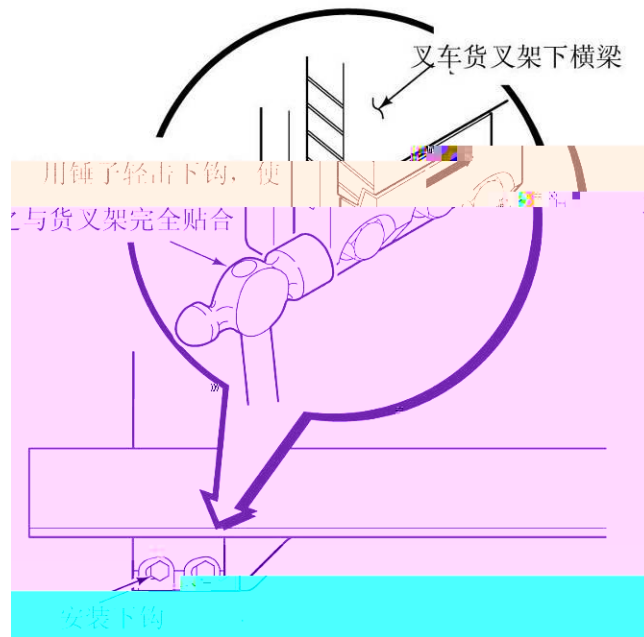

3.6

1.5mm

200

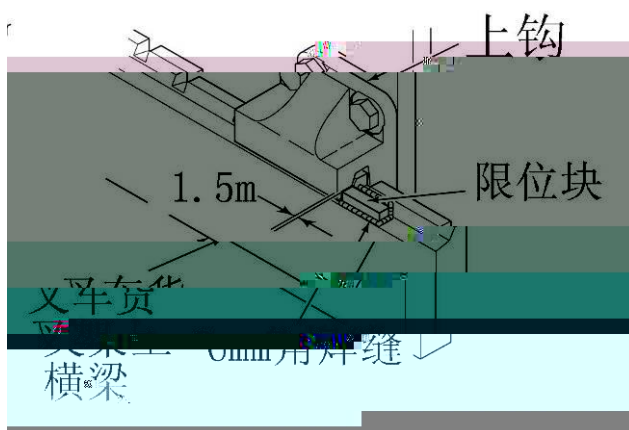



3.7

1



2

45°

3

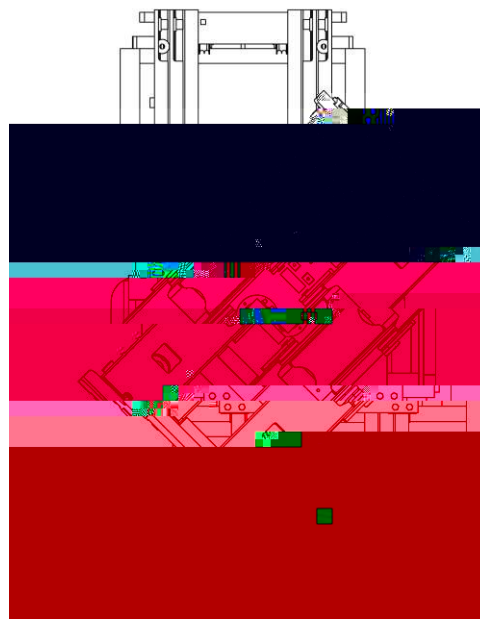

4

3



4

4.1

/

8cm

3~4°

30cm

4.2



夹板与纸卷对中

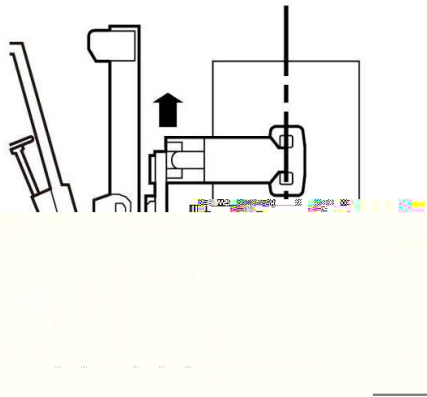

前短卷
定位在
纸上
先将
夹臂在
上

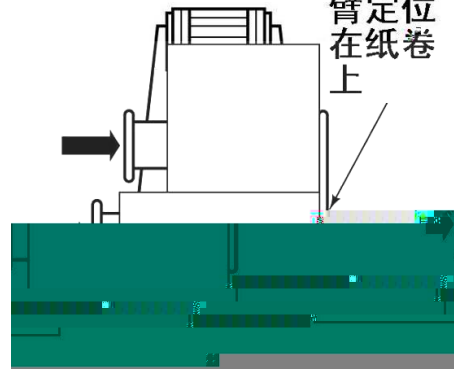

4.4

4.4.1

(1)

2

(1)

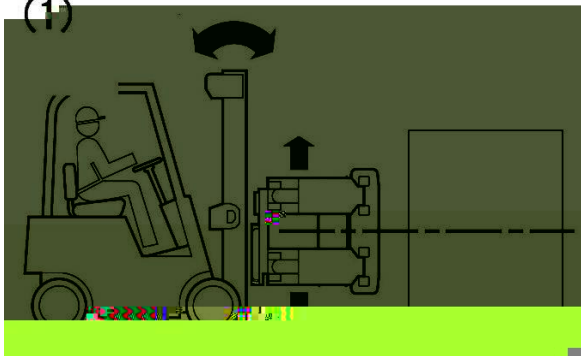

(2)

夹臂再谷拢夹住纸卷

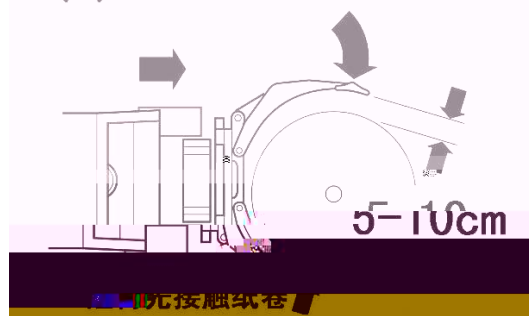



3

4

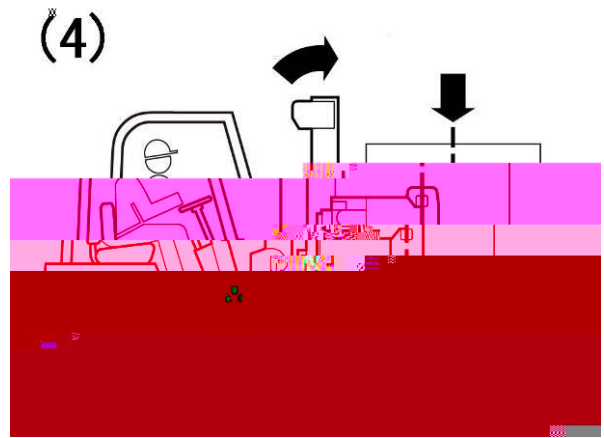
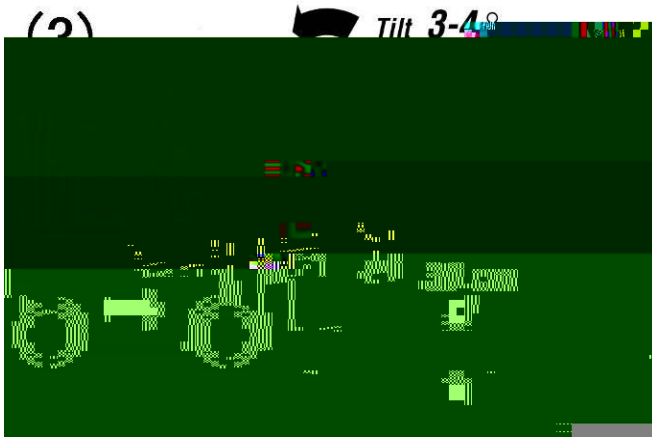

4.4.2

1

2

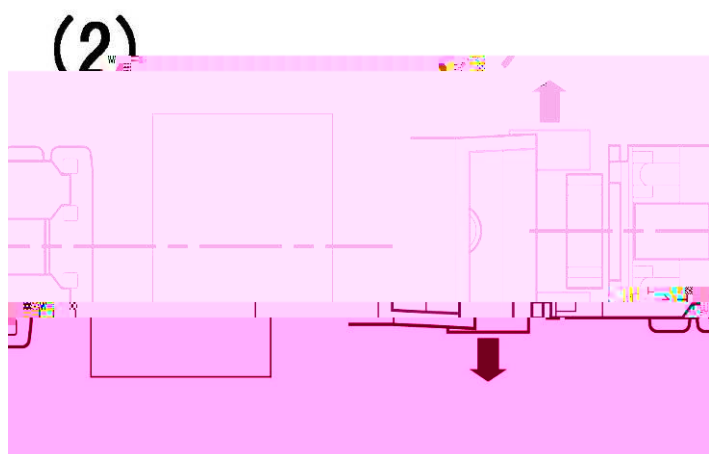
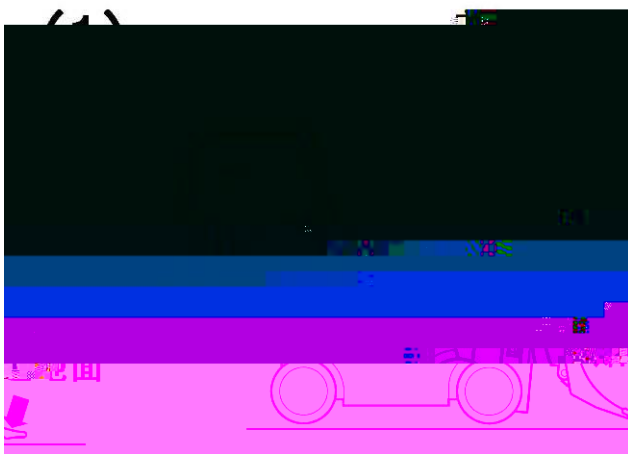

3

4

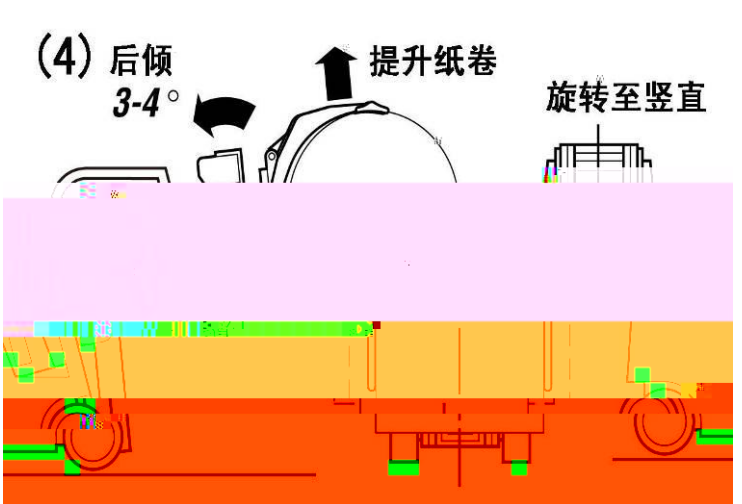
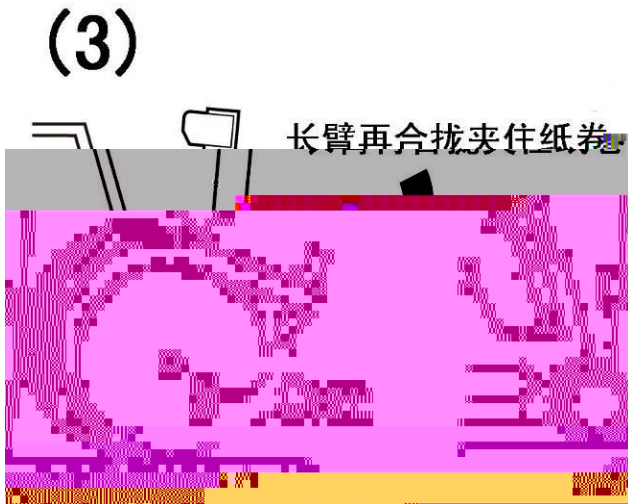



5

(5)

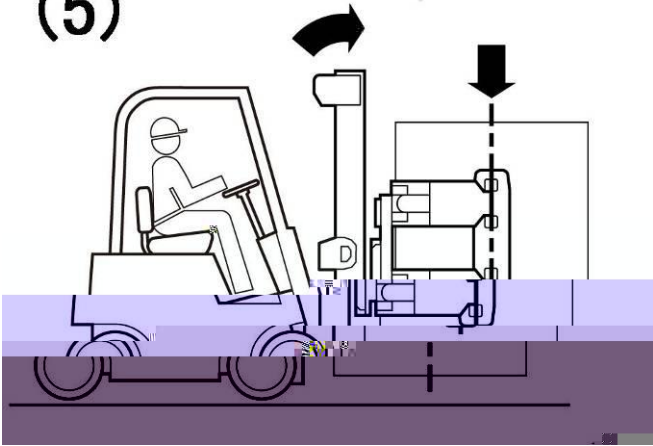



5

5.1 100

100



5. 5



6.1

üü
\$-
3

6.2

“
üü

6.3

†



6.6

6.7

6.8

0.1mm—

0.3mm—





"

"

7.1

7.1.1

1

2 4000

12 2000

"

"

7.2

7.2.1

7.2.2

7.2.3

7.3

7.3.1

7.3.2



7. 3. 3

7. 3. 4

7. 4

/

0556- 5345329/5228123

2025 8 28

